

DS-2CE57H0T-VPITF(C) 5 MP Vandal Fixed Dome Camera



- 5 MP dome camera
- EXIR 2.0: advanced infrared technology with 20 m IR distance
- Water and dust resistant (IP67) and vandal proof (IK10)
- 4 in 1 (4 signals switchable TVI/AHD/CVI/CVBS)

▪ Specification

Camera	
Image Sensor	5 MP CMOS image sensor
Max. Resolution	2560 (H) × 1944 (V)
Min. Illumination	Color: 0.01 Lux @ (F2.0, AGC ON), 0 Lux with IR
Shutter Time	PAL: 1/25 s to 1/50, 000 s NTSC: 1/30 s to 1/50, 000 s
Day & Night	ICR
Angle Adjustment	Pan: 0 to 355°, Tilt: 0 to 75°, Rotation 0 to 355°
Signal System	PAL/NTSC
Lens	
Lens Type	2.8 mm, 3.6 mm, 6 mm fixed lens
Focal Length & FOV	2.8 mm, horizontal FOV: 86°, vertical FOV: 63°, diagonal FOV: 120° 3.6 mm, horizontal FOV: 80°, vertical FOV: 63°, diagonal FOV: 112° 6 mm, horizontal FOV: 55°, vertical FOV: 40°, diagonal FOV: 70°
Lens Mount	M12
Image	
Image Parameters Switch	STD/HIGH-SAT
Image Settings	Brightness, Sharpness, DNR, Mirror, Smart IR
Frame Rate	TVI: 5M@20fps, 4M@30fps, 4M@25fps, 1080p@30fps, 1080p@25fps AHD: 5M@20fps, 4M@30fps, 4M@25fps CVI: 4M@30fps, 4M@25fps CVBS: PAL/NTSC
Day/Night Mode	Auto/Color/BW (Black and White)
Wide Dynamic Range (WDR)	Digital WDR
Image Enhancement	Yes
Image Enhancement	Yes
White Balance	ATW/MANUAL
AGC	Support
Interface	
Video Output	TVI/AHD/CVI/CVBS
General	
Material	Metal
Dimension	Φ 110.8 mm × 84.7 mm (Φ 4.4" × 3.3")
Weight	Approx. 362 g (0.80 lb.)
Operating Condition	-40 °C to 60 °C (-40 °F to 140 °F), humidity: 90% or less (non-condensation)
Communication	HIKVISION-C
Language	English
Power Supply	12 VDC ±25%
Consumption	Max. 4.3 W
IR Range	Up to 20 m
Approval	
Protection	IP67 IK10

▪ Available Model

DS-2CE57HOT-VPITF(2.8mm)(C)

DS-2CE57H0T-VPITF(3.6mm)(C)





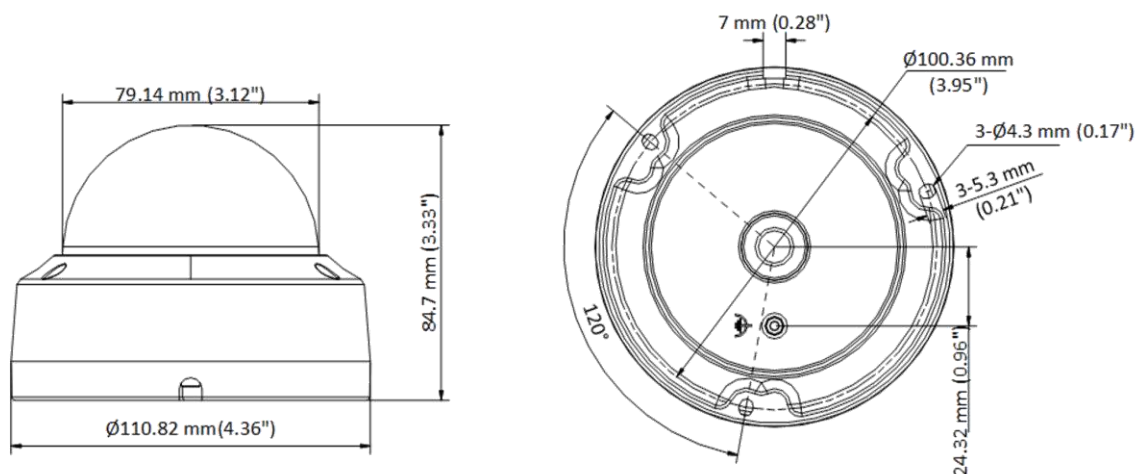

DS-2CE57H0T-VPITF(6mm)(C)

▪ **Dimension**



▪ **Accessory**

▪ **Optional**

DS-1272ZJ-110B Wall mount	DS-1258ZJ Wall mount	DS-1272ZJ-110 Wall mount	DS-1271ZJ-110 Pendant Mount	DS-1275ZJ-SUS Vertical pole mount
				
DS-1280ZJ-DM18 Junction box	DS-1259ZJ Inclined ceiling mount			
				

Headquarters

No.555 Qianmo Road, Binjiang District,
Hangzhou 310051, China
T +86-571-8807-5998
www.hikvision.com



Follow us on social media to get the latest product and solution information.

